

Article number: 209512M1255361NI

Description: E+G Pulling latches for clamps GN 852
GN 951.2-M12-55-361-NI

Measures

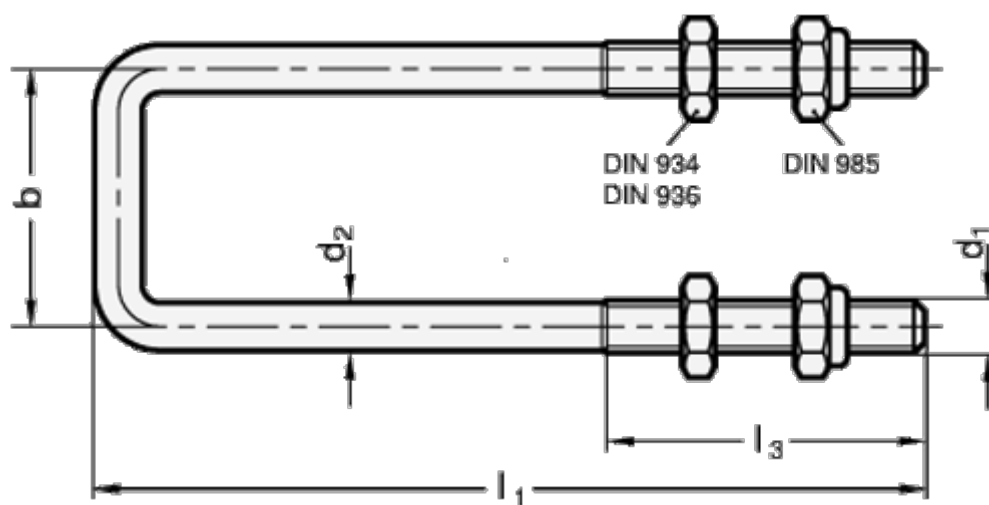

$b = 55$
 $d_1 = M12$
 $d_2 = 10.8$
 $l_1 = 361$
 $l_3 = 60.0$